



**DUGASS
HYDRAULICS**

STEEL TUBE AND TUBE FITTINGS



RASTELLIRACCORDI

STEEL TUBE FITTINGS - MADE IN ITALY

SECTION E

www.dugass.co.za

T: 011 051 9738

E: admin@dugass.co.za

Hydraulic Line Tube Connectors

Steel Tubing & Tube Connectors

Hydraulic Steel Tubing	ST
Zista Brake Tubing	BUNDY
Blanking Plugs	BUZ_L/S
Cutting Rings	D_L/S
Straight Stud Standpipes	EVGE ED
Adjustable Barrel Run Tees	EVL
Adjustable Branch Tees	EVT
Adjustable Elbows	EVW
Straight Union/Coupling	G_LL/L/S
Straight Female Stud Coupler - BSP	GAI_LR/S
Straight Male Stud Coupler - BSP	GE_LR/SR
Straight Male Stud Coupler - NPT	GE_L/S
Straight Male Stud Coupler - Metric ED	GE_LME
Straight Reducing Union	GR
Reducing Connections	KOR
Nuts	M_L
Pressure Guage Connector - BSP	MAV_LR/S
Male/Female Reducing Bush	RI
Straight BulkHead	SV_L/S
Equal Tees	T_L/S
Locking Component Plug - BSP	VSTI_ED
Elbow Fitting	W_L/S
Male Stud Elbow - BSPT	WE_LR
Male Stud Elbow - NPT	WE_L/S
Elbow BulkHead	WSV_L/S
2-Way BSP Female Ball Valves	BKHR
Check Valve	VR
Pipe Clamps - Single - Polypropylene - Normal Duty	CL

HYDRAULIC STEEL TUBING

DIN 2391, ST37, 4 ANNEALED, PHOSPHATED OILED AND PLUGGED - METRIC TUBING

Size	Price	W.P. in Bars	Visual
6x1		389	   GERMANY
6x1.5		549	
6x2		692	
8x1		333	
8x1.5		431	
8x2		549	
10x1		282	
10x1.5		373	
12x1		235	
12x1.5		353	
12x2		409	
14x2		403	
15x1		188	
15x1.5		282	
16x1.5		264	
16x2		353	
18x1.5		196	
18x2		313	
20x1.5		194	
20x2		282	
20x2.5		353	
22x1.5		192	
22x2		256	
25x2		276	
25x2.5		282	
25x3		338	
28x2		201	
28x3		302	
30x2.5		235	
30x3		282	
35x3		242	
38x3		223	
38x4		297	
42x3		201	

ZISTA BRAKE TUBING

DIN 74234-B6 - DIN 2394-2/C-94 - STEEL GRADE RST 34.2



Part No.	Price	Size	W.P. in Bars	Visual
BUNDY-03		4.760 x 0.700	299	
BUNDY-04		6.350 x 0.710	239	
BUNDY-06		9.530 x 0.890	220	
BUNDY-08		12.70 x 1.00	190	
BUNDY -06M		6.00 x 0.700	253	
BUNDY -08M		8.00 x 0.700	190	
BUNDY -10M		10.00 x 1.00	236	
BUNDY -12M		12.00 x 1.00	196	

HYDRAULIC LINE TUBE CONNECTORS

BUZ
BLANKING PLUGS

Part No.	Price	Size (mm)	Part No.	Price	Size (mm)
BUZ06L/S		6	BUZ16S		16
BUZ08L/S		8	BUZ20S		20
BUZ10L/S		10	BUZ22L		22
BUZ12L/S		12	BUZ25S		25
BUZ15L		15	BUZ30S		30
BUZ18L		18	BUZ38S		38



D		CUTTING RINGS		EVGE-ED	STRAIGHT STUD STANDPIPES (BSPP-ED)		
Part No.	Price	Size (mm)	Visual	Part No.	Price	Size (mm)	Visual
D04LL		4		EVGE06LRED		6 x 1/8 BSPP	
D06L/S		6		EVGE08LRED		8 x 1/4 BSPP	
D08L/S		8		EVGE10LRED		10 x 1/4 BSPP	
D10L/S		10		EVGE12LRED		12 x 3/8 BSPP	
D12L/S		12		EVGE15LRED		15 x 1/2 BSPP	
D15L		15		EVGE18LRE		18 x 1/2 BSPP	
D18L		18		EVGE06SRE		6 x 1/8 BSPP	
D22L		22		EVGE08SRE		8 x 1/4 BSPP	
D28L		28		EVGE10SRE		10 x 3/8 BSPP	
D35L		35		EVGE12SRE		12 x 3/8 BSPP	
D42L		42		EVGE16SRE		16 x 1/2 BSPP	
D14S		14		EVGE20SRE		20 x 3/4 BSPP	
D16S		16					
D20S		20					
D25S		25					
D30S		30					
D35L		35					
D38S		38					

EVL
ADJUSTABLE BARREL RUN TEES

Part No.	Price	Size (mm)	Part No.	Price	Size (mm)
EVL06L		6	EVL12S		12
EVL08L		8	EVL16S		16
EVL10L		10	EVL20S		20
EVL12L		12	EVL25S		25
EVL15L		15			
EVL18L		18			
EVL22L		22			





HYDRAULIC LINE TUBE CONNECTORS

EVW				ADJUSTABLE ELBOWS				G				STRAIGHT UNION / COUPLING				
Part No.	Price	Size (mm)	Visual	Part No.	Price	Size (mm)	Visual	Part No.	Price	Size (mm)	Visual	Part No.	Price	Size (mm)	Visual	
EVW06L		6		G04LL		4		G06LL		6		G08LL		8		
EVW08L		8		G06L		6			G08L		8		G10L		10	
EVW10L		10		G12L		12			G15L		15		G18L		18	
EVW12L		12		G22L		22			G28L		28		G35L		35	
EVW15L		15		G42L		42			G42L		42		G06S		6	
EVW18L		18		G06S		6			G08S		8		G10S		10	
EVW22L		22		G10S		10			G12S		12		G14S		14	
EVW28L		28		G12S		12			G16S		16		G20S		20	
EVW35L		35		G14S		14			G25S		25		G30S		30	
EVW42L		42		G16S		16			G30S		30		G38S		38	
EVW06S		6		G20S		20										
EVW08S		8		G25S		25										
EVW10S		10		G30S		30										
EVW12S		12		G38S		38										
EVW14S		14														
EVW16S		16														
EVW20S		20														
EVW25S		25														
EVW30S		30														
EVW38S		38														

GAI				STRAIGHT FEMALE STUD COUPLINGS -BSP			
Part No.	Price	Size (mm)	Visual	Part No.	Price	Size (mm)	Visual
GAI06LR		6 x 1/8 BSPP		GAI08LR		8 x 1/4 BSPP	
GAI10LR		10 x 1/4 BSPP		GAI12LR		12 x 3/8 BSPP	
GAI12LR		12 x 3/8 BSPP		GAI18LR		18 x 1/2 BSPP	
GAI18LR		18 x 1/2 BSPP		GAI06SR		6 x 1/8 BSPP	
GAI06SR		6 x 1/8 BSPP		GAI08SR		8 x 1/4 BSPP	
GAI08SR		8 x 1/4 BSPP		GAI10SR		10 x 3/8 BSPP	
GAI10SR		10 x 3/8 BSPP		GAI12SR		12 x 3/8 BSPP	
GAI12SR		12 x 3/8 BSPP		GAI14SR		14 x 1/2 BSPP	
GAI14SR		14 x 1/2 BSPP					

HYDRAULIC LINE TUBE CONNECTORS

GE-R STRAIGHT MALE STUD COUPLER - BSP				GE-NPT STRAIGHT MALE STUD COUPLER - NPT			
Part No.	Price	Size (mm)	Visual	Part No.	Price	Size (mm)	Visual
GE06LR-1/8		6 x 1/8 BSPP		GE04LL1/8NPT		4 x 1/8 NPT	
GE06LR-1/4		6 x 1/4 BSPP		GE06LL1/8NPT		6 x 1/8 NPT	
GE06LR-3/8		6 x 3/8 BSPP		GE06L1/8NPT		6 x 1/8 NPT	
GE08LR-1/8		8 x 1/8 BSPP		GE06L1/4NPT		6 x 1/4 NPT	
GE08LR-1/4		8 x 1/4 BSPP		GE08L1/8NPT		8 x 1/8 NPT	
GE08LR-3/8		8 x 3/8 BSPP		GE08L1/4NPT		8 x 1/4 NPT	
GE10LR-1/8		10 x 1/8 BSPP		GE08L3/8NPT		8 x 3/8 NPT	
GE10LR-1/4		10 x 1/4 BSPP		GE10L1/4NPT		10 x 1/4 NPT	
GE10LR-3/8		10 x 3/8 BSPP		GE10L3/8NPT		10 x 3/8 NPT	
GE10LR-1/2		10 x 1/2 BSPP		GE10L1/2NPT		10 x 1/2 NPT	
GE12LR-1/4		12 x 1/4 BSPP		GE12L1/4NPT		12 x 1/4 NPT	
GE12LR-3/8		12 x 3/8 BSPP		GE12L3/8NPT		12 x 3/8 NPT	
GE12LR-1/2		12 x 1/2 BSPP		GE12L1/2NPT		12 x 1/2 NPT	
GE15LR-3/8		15 x 3/8 BSPP		GE15L3/8NPT		15 x 3/8 NPT	
GE15LR-1/2		15 x 1/2 BSPP		GE15L1/2NPT		15 x 1/2 NPT	
GE15LR-3/4		15 x 3/4 BSPP		GE18L1/2NPT		18 x 1/2 NPT	
GE18LR-1/2		18 x 1/2 BSPP		GE18L3/4NPT		18 x 3/4 NPT	
GE18LR-3/4		18 x 3/4 BSPP		GE22L1/2NPT		22 x 1/2 NPT	
GE28LR-3/4		28 x 3/4 BSPP		GE22L3/4NPT		22 x 3/4 NPT	
GE28LR-1		28 x 1 BSPP		GE35L1 1/4NPT		35 x 1 1/4 NPT	
GE35LR-1 1/4		35 x 1 1/4 BSPP		GE35L1 1/2NPT		35 x 1 1/2 NPT	
GE08SR-1/4		8 x 1/4 BSPP		GE42L1 1/2NPT		42 x 1 1/2 NPT	
GE10SR-3/8		10 x 3/8 BSPP		GE06S1/4NPT		6 x 1/4 NPT	
GE12SR-1/4		12 x 1/4 BSPP		GE08S1/4NPT		8 x 1/4 NPT	
GE12SR-3/8		12 x 3/8 BSPP		GE10S1/4NPT		10 x 1/4 NPT	
GE12SR-1/2		12 x 1/2 BSPP		GE10S3/8NPT		10 x 3/8 NPT	
GE16SR-1/2		16 x 1/2 BSPP		GE12S1/4NPT		12 x 1/4 NPT	
GE16SR-3/8		16 x 3/8 BSPP		GE12S3/8NPT		12 x 3/8 NPT	
GE16SR-3/4		16 x 3/4 BSPP		GE12S1/2NPT		12 x 1/2 NPT	
GE20SR-1/2		20 x 1/2 BSPP		GE14S1/2NPT		14 x 1/2 NPT	
GE20SR-3/4		20 x 3/4 BSPP		GE16S3/8NPT		16 x 3/8 NPT	
GE20SR-1		20 x 1 BSPP		GE16S1/2NPT		16 x 1/2 NPT	
GE25SR-3/4		25 x 3/4 BSPP		GE16S3/4NPT		16 x 3/4 NPT	
GE25SR-1		25 x 1 BSPP	GE20S1/2NPT		20 x 1/2 NPT		
GE30SR-1		30 x 1 BSPP	GE20S3/4NPT		20 x 3/4 NPT		
GE30SR-1 1/4		30 x 1 1/4 BSPP	GE25S3/4NPT		25 x 3/4 NPT		
GE35LR-1		35 x 1 BSPP	GE25S1NPT		25 x 1 NPT		
GE38SR-1 1/2		38 X 1 1/2 BSPP	GE30S1NPT		30 x 1 NPT		
			GE38S1 1/2NPT		38 x 1 1/2 NPT		

HYDRAULIC LINE TUBE CONNECTORS

GE-MED
STR. MALE STUD COUPLER - METRIC ED

Part No.	Price	Size (mm)	Visual
GE06LMED		6 x M10 x 1	
GE08LMED		8 x M12 x 1.5	
GE10LMED		10 x M14 x 1.5	
GE12LMED		12 x M16 x 1.5	
GE08LM		8 x M12 x 1.5	
GE08LM 16X1.5		8 x M16 x 1.5	
GE10LM		10 x M14 x 1.5	
GE10LM 16X1.5		10 x M16 x 1.5	
GE10LM 18X1.5		10 x M18 x 1.5	
GE12LM		12 x M16 x 1.5	
GE12LM 18X1.5		12 x M18 x 1.5	
GE15LM		15 x M18 x 1.5	
GE15LM 22X1.5		15 x M22 x 1.5	
GE16SM		16 x M22 x 1.5	

GR
STRAIGHT REDUCING UNION

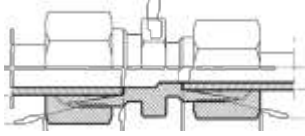

Part No.	Price	Size (mm)	Visual
GR10/08LGR			
GR12/10LGR			
GR15/12LGR			
GR18/15LGR			
GR22/15LGR			
GR22/18LGR			
GR20/12SGR			

HYDRAULIC LINE TUBE CONNECTORS



KOR
REDUCING CONNECTIONS

Part No.	Price	Size (mm)	Visual
KOR08/06L			
KOR10/08L			
KOR12/06L			
KOR12/08L			
KOR12/10L			
KOR15/12L			
KOR18/10L			
KOR18/12L			
KOR18/15L			
KOR22/18L			
KOR16/12S			
KOR20/12S			
KOR25/12S			
KOR25/20S			

M
NUTS
MAV
PRESSURE GAUGE CONNECTOR - BSP

Part No.	Price	Size (mm)	Visual	Part No.	Price	Size (mm)	Visual
M06L		6		MAV06LR		6 x 1/8 BSP	
M06LL		6		MAV08LR		6 x 1/4 BSP	
M08L		8		MAV10LR		8 x 1/4 BSP	
M10L		10		MAV12LR		10 x 1/4 BSP	
M12L		12		MAV06SR		10 x 3/8 BSP	
M15L		15		MAV08SR		10 x 1/2 BSP	
M18L		18		MAV10SR		12 x 1/4 BSP	
M22L		22		MAV12SR		12 x 3/8 BSP	
M28L		28					
M35L		35					
M42L		42					
M06S		6					
M08S		8					
M10S		10					
M12S		12					
M14S		14					
M16S		16					
M20S		20					
M25S		25					
M30S		30					
M38S		38					

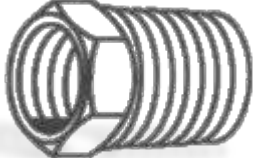
HYDRAULIC LINE TUBE CONNECTORS

RI			SV				
MALE/FEMALE REDUCING BUSH			STRAIGHT BULKHEAD				
Part No.	Price	Visual	Part No.	Price	Size (mm)	Visual	
RI1/8X1/4			SV06L		6		
RI1/4X1/8			SV08L		8		
RI1/4X3/8			SV10L		10		
RI1/4X1/2			SV12L		12		
RI1/4X3/4			SV15L		15		
RI3/8X1/8			SV18L		18		
RI3/8X1/4			SV22L		22		
RI3/8X1/2			SV06S		6		
RI1/2X1/4			SV08S		8		
RI1/2X3/8			SV10S		10		
RI1/2X1			SV12S		12		
RI3/4X1/4			SV16S		16		
RI3/4X3/8			SV20S		20		
RI3/4X1/2			SV25S		25		
RI1X1/2							
RI1X3/4							
RI11/4X3/4							
RI11/4X1/2							
RI11/4X1							

T			VSTI			
EQUAL TEES			LOCKING COMPONENT - PLUG - BSPP			
Part No.	Price	Size (mm)	Visual	Part No.	Price	Visual
T06L		6		VSTI1/8ED		
T08L		8		VSTI1/4ED		
T10L		10		VSTI3/8ED		
T12L		12		VSTI1/2ED		
T15L		15		VSTI3/4ED		
T18L		18		VSTI1ED		
T22L		22		VSTI11/4ED		
T28L		6		VSTI11/2ED		
T06S		6		VSTI11/4E		
T08S		8				
T10S		10				
T12S		12				
T14S		14				
T16S		16				
T20S		20				
T25S		25				
T30S		30				

HYDRAULIC LINE TUBE CONNECTORS

W				ELBOW FITTING				WE-NPT				MALE STUD ELBOW - NPT				
Part No.	Price	Size (mm)	Visual	Part No.	Price	Size (mm)	Visual	Part No.	Price	Size (mm)	Visual	Part No.	Price	Size (mm)	Visual	
W04LL		4		WE06L-1/8NPT		6 x 1/8 NPT		WE06L-1/4NPT		6 x 1/4 NPT		WE08L-1/4NPT		8 x 1/4 NPT		
W06L		6		WE10L-3/8NPT		10 x 3/8 NPT			WE10L-1/4NPT		10 x 1/4 NPT		WE12L-1/4NPT		12 x 1/4 NPT	
W08L		8		WE12L-3/8NPT		12 x 3/8 NPT			WE12L-1/2NPT		12 x 1/2 NPT		WE22L-3/8NPT		22 x 3/4 NPT	
W10L		10		WE28L-1NPT		28 x 1 NPT			WE6L-1/4NPT		6 x 1/4 NPT		WE14L-1/2NPT		14 x 1/2 NPT	
W12L		12		WE12L-1/2NPT		12 x 1/2 NPT			WE16L-1/2NPT		16 x 1/2 NPT		WE20L-3/4NPT		20 x 3/4 NPT	
W15L		15		WE25L-1NPT		25 x 1 NPT										
W18L		18														
W22L		22														
W28L		6														
W06S		6														
W08S		8														
W10S		10														
W12S		12														
W16S		16														
W20S		20														
W25S		25														
W38S		38														

WE-R				MALE STUD ELBOW - BSPP				WSV				ELBOW BULKHEAD				
Part No.	Price	Size (mm)	Visual	Part No.	Price	Size (mm)	Visual	Part No.	Price	Size (mm)	Visual	Part No.	Price	Size (mm)	Visual	
WE06LR1/8		6 x 1/8 BSPP		WSV06L		6		WSV06L		6		WSV08L		8		
WE06LR1/4		6 x 1/4 BSPP		WSV10L		10			WSV10L		10		WSV12L		12	
WE08LR1/4		8 x 1/4 BSPP		WSV12L		12			WSV12L		12		WSV15L		15	
WE10LR1/4		10 x 1/4 BSPP		WSV15L		15			WSV15L		15		WSV18L		18	
WE12LR1/4		12 x 1/4 BSPP		WSV18L		18			WSV18L		18		WSV10S		10	
WE12LR3/8		12 x 3/8 BSPP		WSV10S		10			WSV10S		10		WSV12S		12	
WE18LR1/2		18 x 1/2 BSPP		WSV12S		12			WSV12S		12		WSV16S		16	
WE16SR1/2		16 x 1/2 BSPP		WSV16S		16			WSV16S		16					

PIPE CLAMPS

CL
PIPE CLAMPS - SINGLE - POLYPROPYLENE - NORMAL DUTY

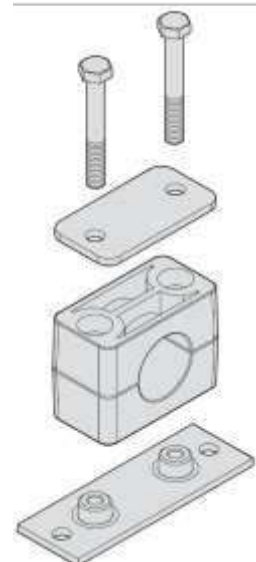
Part No.	Price	Size (mm)	Visual
CL06		6	
CL08		8	
CL10		10	
CL12		12	
CL14		14	
CL15		15	
CL16		16	
CL18		18	
CL20		20	
CL22		22	
CL25		25	
CL28		28	
CL30		30	
CL32		32	
CL35		35	
CL38		38	
CL42		42	

CL
PIPE CLAMPS - TWIN - POLYPROPYLENE - NORMAL DUTY

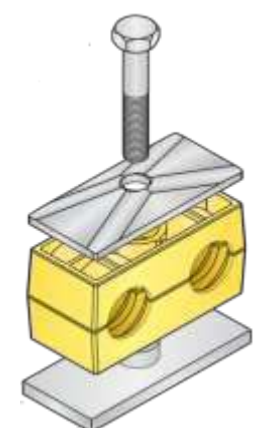
Part No.	Price	Size (mm)	Visual
CD12		6	
CD15		8	
CD16		10	
CD18		12	
CD20		14	
CD22		15	
CD25		16	
CD28		18	